

Raffles Girls' Primary School

Practice Paper 1A

Name: _____

Class: _____ Date: _____

For each Question from 1 to 28, four options are given. One of them is the correct answer. Make your choice (1, 2, 3 or 4).

Shade the correct oval (1, 2, 3 or 4) on the Optical Answer Sheet (OAS).

1. Which one of the following about plants and animals is correct?

- (1) Both will grow and die.
- (2) Both give birth to their young.
- (3) Both can move from one place to another.
- (4) Both depend on other living things for food.

2. The table below shows how some living things can be grouped.

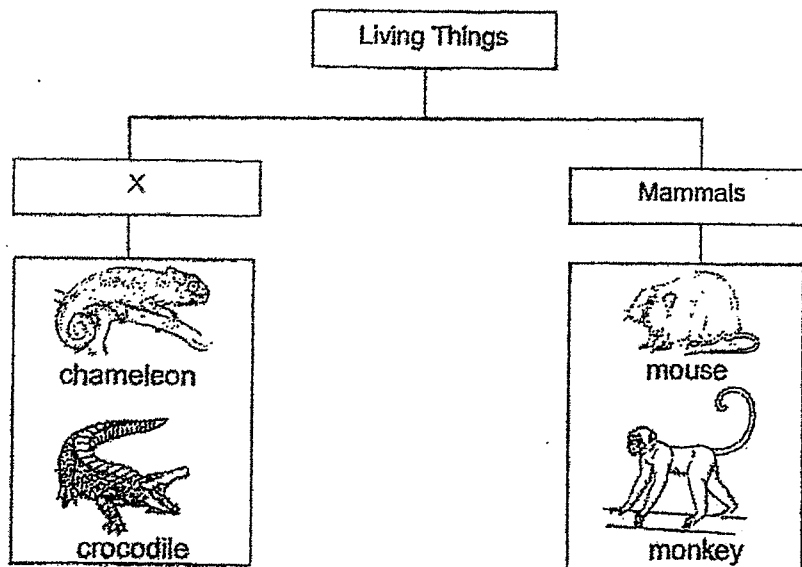

Which one of the following is the most suitable heading for group X?

- (1) Fungi
- (2) Insects
- (3) Reptiles
- (4) Bacteria

3. Which of the following statements is true about all fungi?

- (1) They are poisonous.
- (2) They make their own food.
- (3) They reproduce by spores.
- (4) They can only be seen under a microscope.

4. Study the items below.

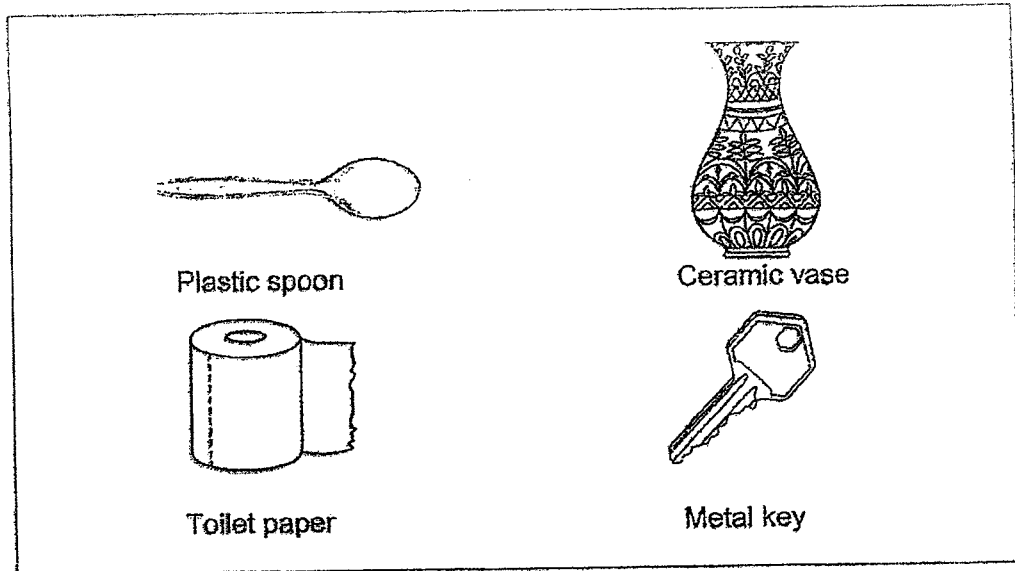

Which one of the following items is not waterproof?

- (1) Metal key
- (2) Toilet paper
- (3) Plastic spoon
- (4) Ceramic vase

5. Which part of the plant below, A, B, C or D, is responsible to hold the plant upright?

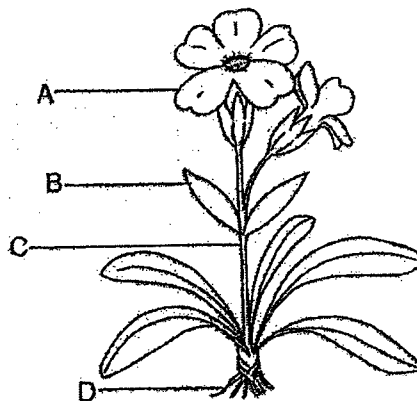

- (1) A
- (2) B
- (3) C
- (4) D

6. The following shows a 3-stage life cycle.

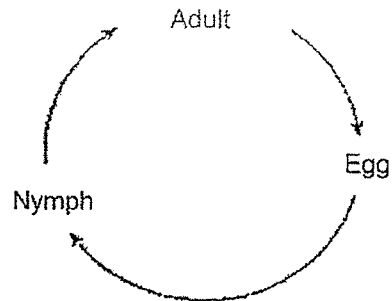

Which of the following animals goes through the above 3-stage life cycle?

- (1) beetle
 - (2) chicken
 - (3) butterfly
 - (4) cockroach
7. Which one of the following is not matter?
- (1) Air
 - (2) Light
 - (3) Water
 - (4) Bottle
8. Bala placed a magnet near Bar M on a table. He observed that both the magnet and Bar M pushed away from each other when the magnet got close to the bar.

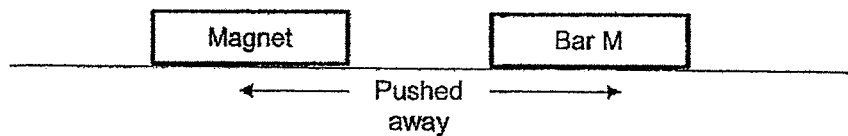

- (1) Bar M is non-magnetic.
- (2) Bar M is made of a magnetic material.
- (3) Bar M is also a magnet so it repelled the magnet.
- (4) Bar M is also a magnet so it attracted the magnet.

9. Which one of the following is not a source of heat?

(1)

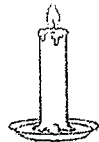

lighted candle

(2)



bonfire

(3)

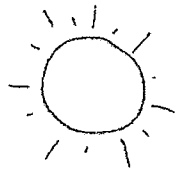

The Sun

(4)



mirror

10. A man is standing between a lamp and a wall. His shadow is formed on the wall when the lamp is switched on as shown in the picture below.

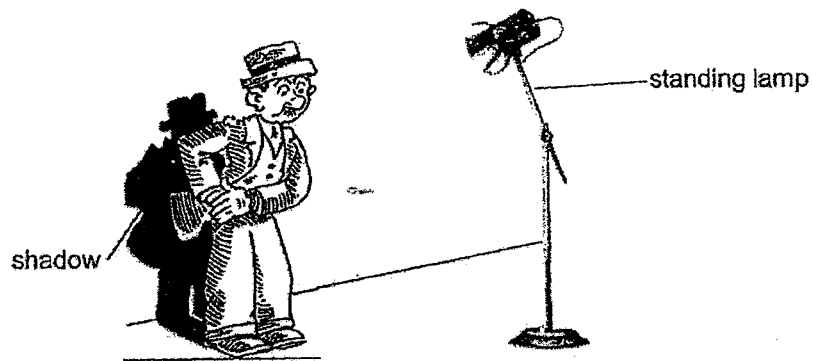

Which one of the following reasons best explains why his shadow was cast on the wall?

- (1) The man was wearing a see-through shirt.
- (2) The room is dark and caused shadows to form.
- (3) The light from the lamp was blocked by the man.
- (4) The light from the lamp was able to pass through the man.

11. Sulin placed five insect Q in a container. She put food and water inside the container weekly. She ensures that there is air in the container. She recorded the number of insect Q inside the container every 2 weeks for 8 weeks as shown below.

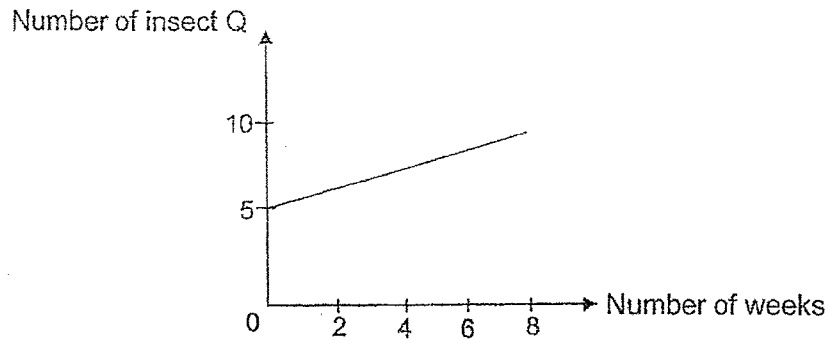

What could be the reason for the change in the number of insect Q over the 8 weeks?

- (1) Some insects died.
 - (2) The insects reproduced.
 - (3) The insects grew bigger.
 - (4) The insects ate a lot of food.
12. The diagram below shows a maize plant.

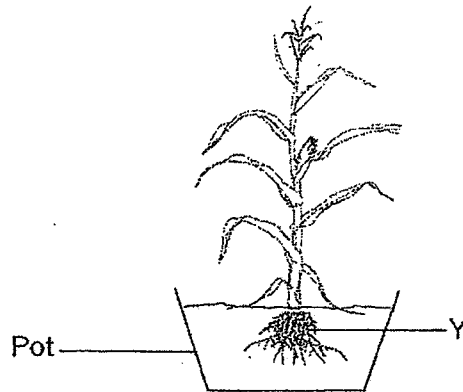

If Part Y is removed, what will happen to the plant after a week?

- A. The plant will wither.
 - B. The plant is unable to make food.
 - C. The plant cannot absorb water and minerals from the soil.
- (1) A only
 - (2) B only
 - (3) A and B only
 - (4) A, B and C

13. Which one of the following properties is true for both air and table?

- (1) They can be seen.
- (2) They take up space.
- (3) They have fixed shapes.
- (4) They have fixed volumes.

14. Geetha attached a strong magnet on her toy sailboat as shown in the diagram below. She brought another strong Magnet X near the sailboat.

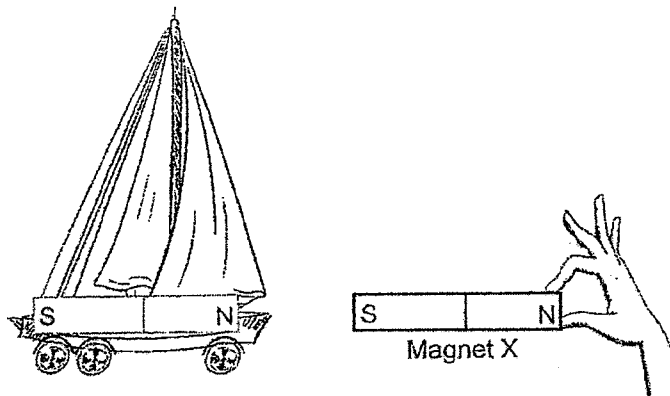

What would most likely happen to the toy sailboat?

- (1) It remains still.
 - (2) It spins around.
 - (3) It moves towards Magnet X.
 - (4) It moves away from Magnet X.
15. Meng went into a room and was able to see the plant on a table in front of him.

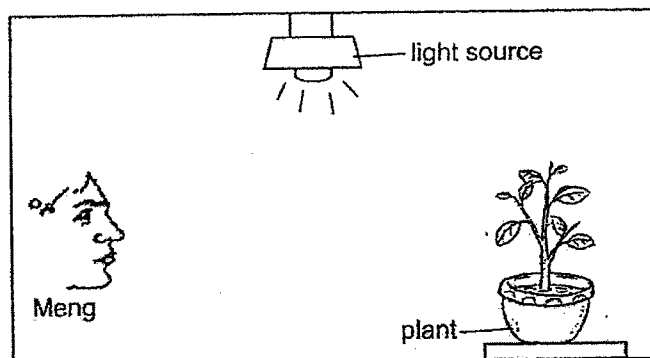

Which of the following explains why Meng is able to see the plant in front of him?

- (1) Light is given out by Meng and shines on the plant.
- (2) Light is given out by the plant and enters Meng's eyes.
- (3) Light is shone on Meng's eyes and reflected to the plant.
- (4) Light is shone on the plant and reflected into Meng's eyes.

16. A wooden ball was placed in between a torch shining on a metal pole as shown in the diagram below.

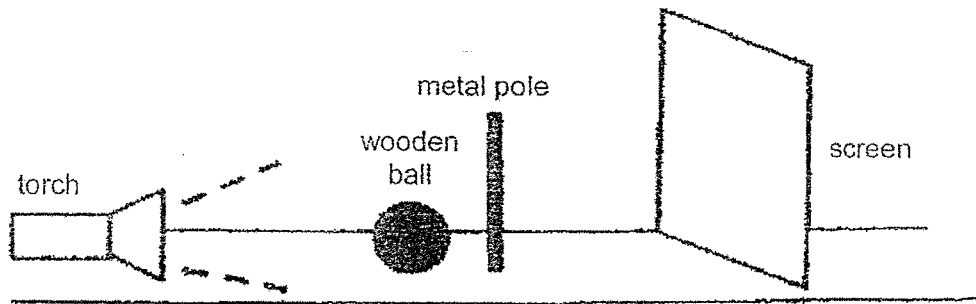

Which one of the following shadows would most likely form on the screen?

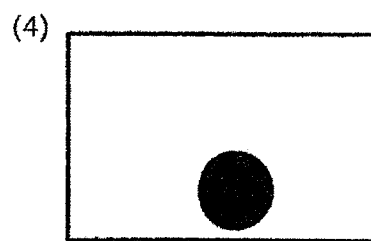
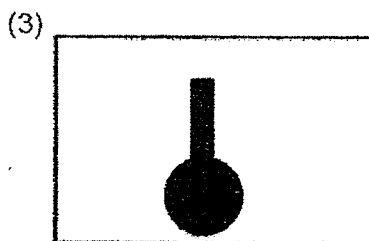
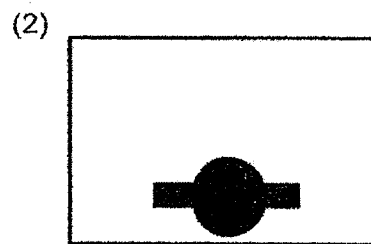
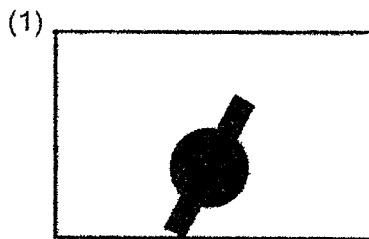

17. Abdul could not remove the metal lid from a glass jar.

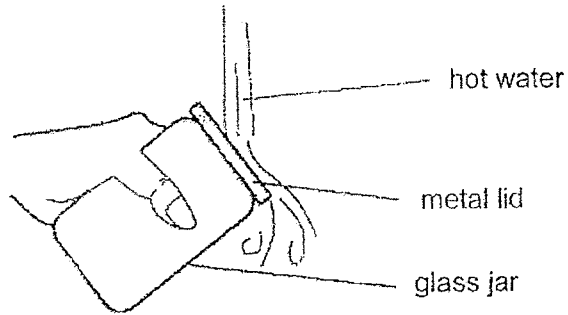

Abdul poured hot water on the metal lid. How does this help to remove the lid from the glass jar?

- (1) Heat causes the metal lid to contract.
- (2) Heat causes the air in the jar to contract.
- (3) Heat causes the lid to expand more than the jar.
- (4) Heat causes the jar to expand more than the lid.

18. Study the flowchart below.

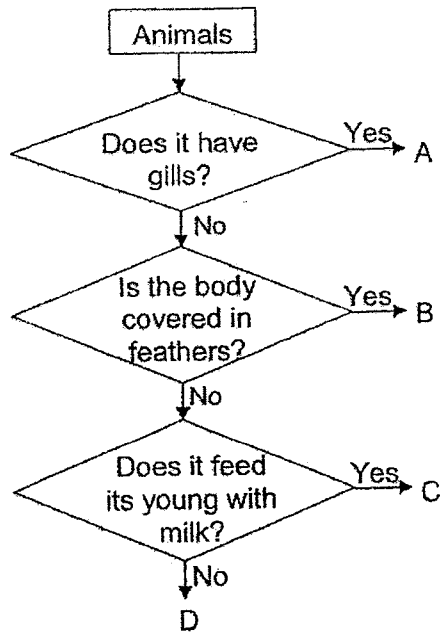

Which one of the following best represents A, B, C and D?

	A	B	C	D
(1)	Fish	Bird	Insect	Mammal
(2)	Fish	Bird	Mammal	Insect
(3)	Reptile	Bird	Insect	Mammal
(4)	Reptile	Fish	Mammal	Bird

19. Pests feed on the leaves and other parts of the crops leaving them unable to be used or sold when farmers harvest them.

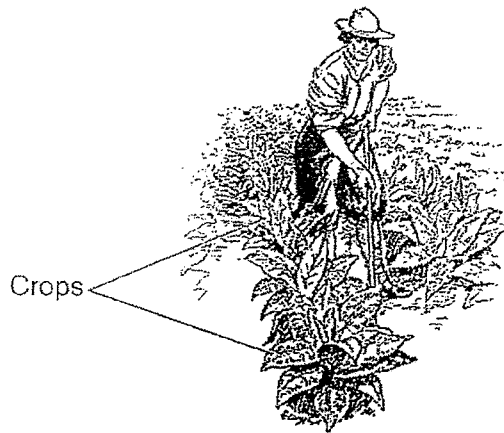

At which stage in the life cycle of a butterfly is it a pest for farmers who grow crops?

- (1) Egg
- (2) Adult
- (3) Pupa
- (4) Larva

20. The following gloves are made of different materials.



Jan, Harold and Ken chose one pair each to put on while they washed their father's car, as shown below.

Jan	Harold	Ken
Woollen gloves	Rubber gloves	Plastic gloves

Jan was told by her father that she cannot wash the car with her chosen gloves. Which one of the following is the reason why she cannot use her woollen gloves?

- (1) Woollen gloves are soft.
- (2) Woollen gloves are flexible.
- (3) Woollen gloves are not waterproof.
- (4) Woollen gloves cannot float on water.

21. Karan placed a metal block inside a cylinder with a plunger as shown below. He tried to push the plunger downwards but he was not able to.

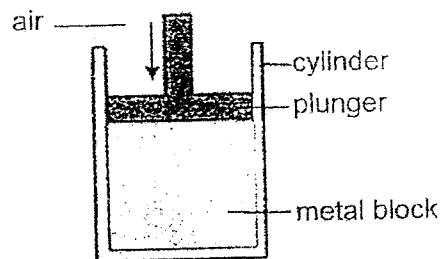

Why is Karan unable to push the plunger downwards?

- (1) The metal block has no definite shape.
 - (2) The air in the container has definite volume.
 - (3) There is air occupying the space in the cylinder.
 - (4) The metal block is occupying the space in the cylinder.
22. Raju lowered an empty glass with a small ball into a container of water until it touched the bottom of the container. The diagram below shows what he observed.

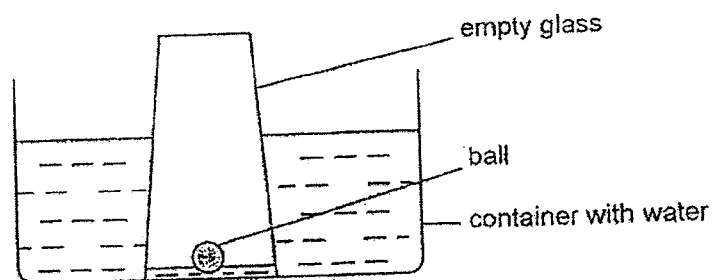

What could be the main reason why there is a difference in water level inside and outside the glass?

- (1) The ball in the glass occupied space.
- (2) The ball pushed the water out of the glass.
- (3) The air trapped in the glass occupied space.
- (4) The air trapped in the glass dissolved in the water.

23. Miss Khan lowered a small stone into a measuring cylinder filled with water as shown below.

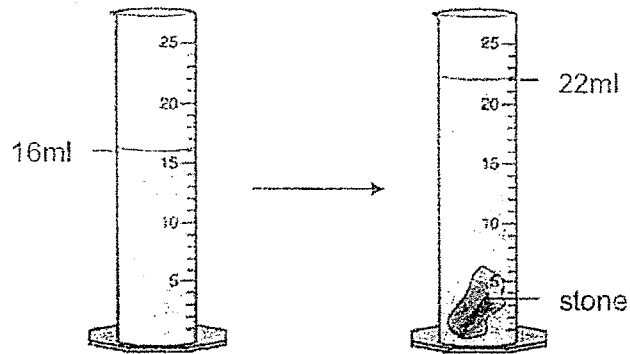

What is she trying to find out from this experiment?

- (1) The mass of the stone.
 - (2) The height of the stone.
 - (3) The volume of the stone.
 - (4) The ability of the stone to sink or float.
24. A metal rod was inserted through three ring magnets as shown below.

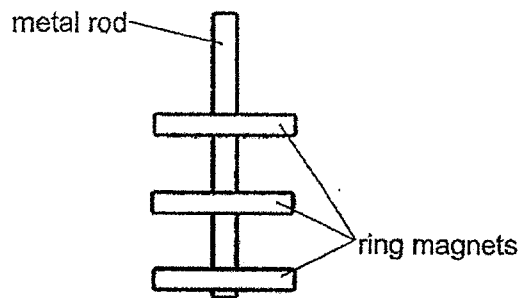

Which of the following reasons explains why the metal rod is not attracted to any of the ring magnets?

- A. The metal rod is shiny.
 - B. The metal rod is a magnet.
 - C. The metal rod is made of magnetic metal.
 - D. The metal rod is made of non-magnetic metal.
- (1) C only
 - (2) D only
 - (3) A and B only
 - (4) A and D only

25. Li Lin set up three magnets, JK, LM and PQ and an iron bar AB as shown in the arrangement below.

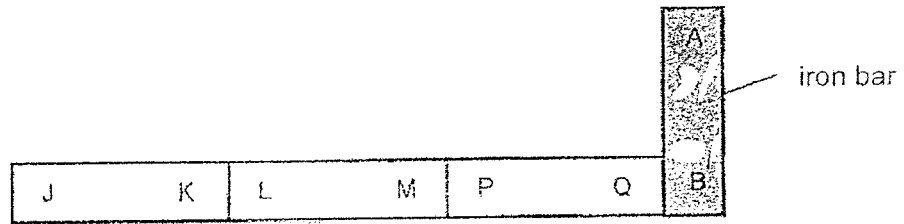

Which of the following arrangements is possible?

(1)

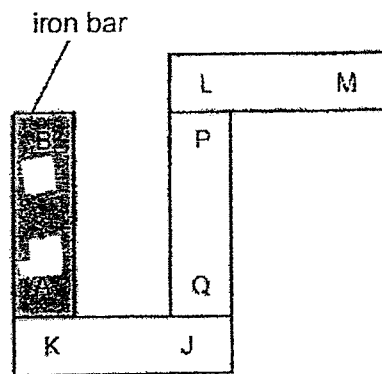

(2)

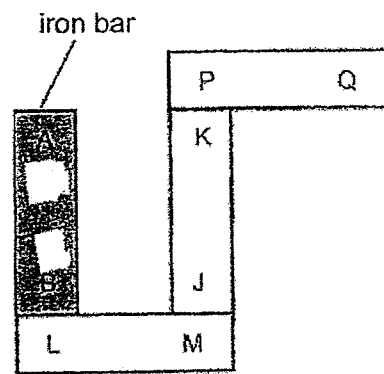

(3)

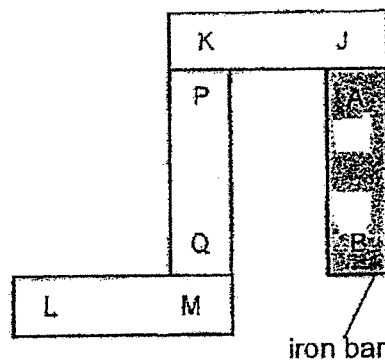

(4)

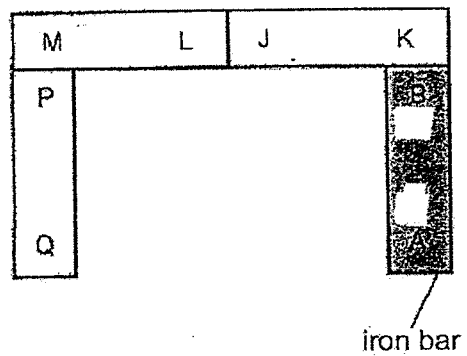

26. The diagram below shows the layout of the stage for a shadow performance.

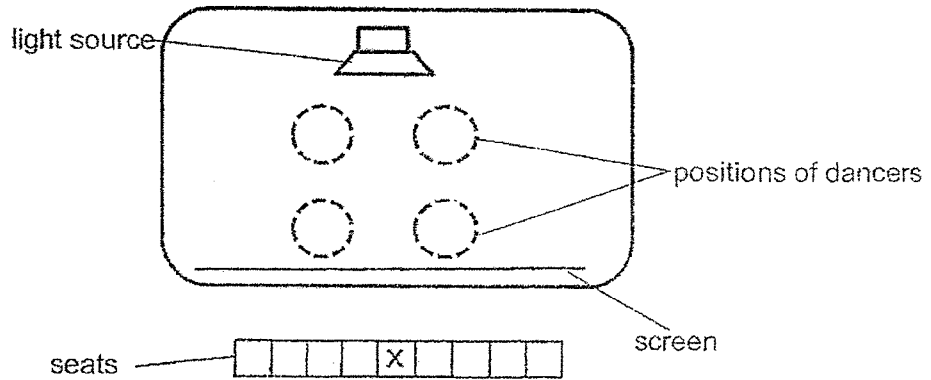

There were two dancers, who were of the same height. The person sitting at X saw the shadows of the dancers on the screen as shown.



Which of the following shows the positions of dancers A and B on stage?

- (1)
- (2)
- (3)
- (4)

27. Mala filled two identical beakers made of different materials W and Z, with an equal amount of water. The beakers were then heated for 10 minutes. A thermometer was used to measure the temperature of water in each beaker and the graph below shows the results.

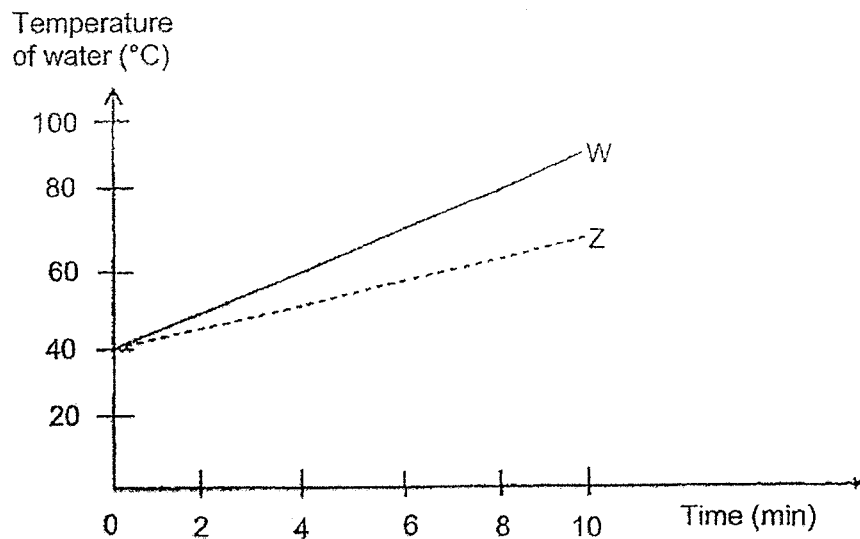

Based on the graph, which of the following statement(s) is/are true?

- A. Water in each beaker was at 40° at the start of the experiment.
- B. Beaker Z was slower than Beaker W in conducting heat to the water.
- C. Both beakers of water reached the same temperature after 10 minutes.

- (1) A only
- (2) C only
- (3) A and B only
- (4) B and C only

28. Ryan placed two bottles, A and B, connected by a glass tubing. A drop of red ink was placed in the glass tubing at Point P. The two bottles were then lowered into basins X and Y containing same amount of water but of different temperature.

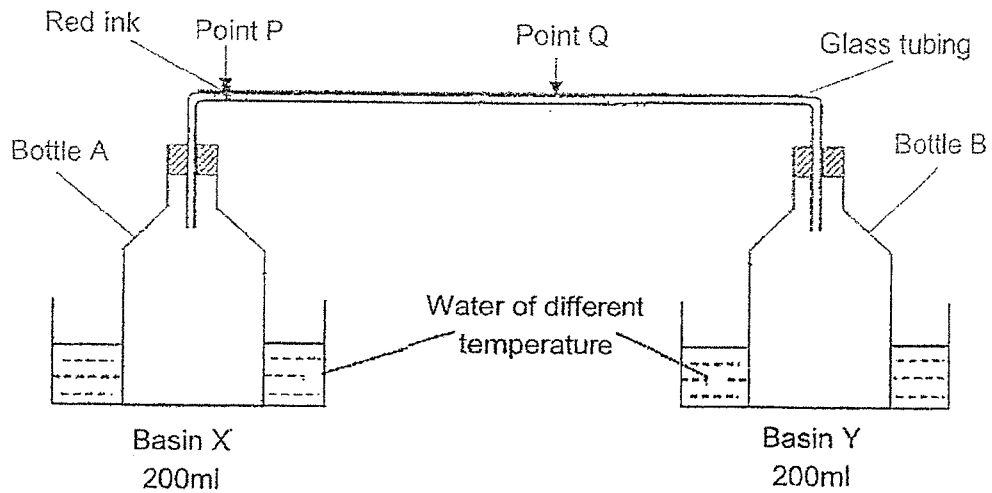

Ryan observed that the red ink moved from Point P to Point Q five minutes later. What could the temperature of the water in Basin X and Y be?

	Basin X	Basin Y
(1)	25°C	25°C
(2)	10°C	25°C
(3)	10°C	90°C
(4)	90°C	25°C

END

YEAR : 2022
LEVEL : PRIMARY 4
SCHOOL : RAFFLES GIRLS' PRIMARY SCHOOL
SUBJECT : SCIENCE
TERM : PRACTICE PAPER 1A

Q1	1	Q2	3	Q3	3	Q4	2	Q5	3
Q6	4	Q7	2	Q8	3	Q9	4	Q10	3
Q11	2	Q12	4	Q13	2	Q14	3	Q15	4
Q16	3	Q17	3	Q18	2	Q19	4	Q20	3
Q21	4	Q22	3	Q23	3	Q24	2	Q25	2
Q26	4	Q27	3	Q28	4				

1
END

